

GMX 系列高温熔体压力传感器 带HART协议和ATEX认证

GMX SERIES MELT PRESSURE TRANSDUCER

用于防爆环境中的压力变送器



GMX系列高温熔体压力变送器其主体由不锈钢制成，其他材料由特殊工艺制造并通过高强度测试。使用钛化合物特殊涂层保护膜片，使其不受黏度和摩擦性较大物质的影响。本系列产品使用寿命长、测量性能精确、食品级传输介质、受温度漂移的影响更小更稳定。因采用NTX环保合金介质填充技术，所以该系列产品可用于食品和制药领域。

产品优势

输出信号4-20mA(+HART)

测量范围 0 ~ 2000bar

200°C 环境下零点标定

精度优于 $\pm 0.25\% \text{ FSO}$ $\pm 0.5\% \text{ FSO}$

6点精细化测试工艺

高温环境温度补偿

技术参数

主要材料	304不锈钢	准确度	优于 $\pm 0.25\% \text{ FSO}$ $\pm 0.5\% \text{ FSO}$
插头	1/2NPT直接出线	最大过载	测量范围 2 倍
膜片	15-5PH不锈钢，高度柔韧	膜片受温度变化的零点漂移	最大0.02 bar/°C
涂层	钛化合物特殊涂层	电路随温度变化零点调整	最大 0.003% from ev./°C
供电	12...36VDC	膜片最高耐温	耐温可达300°C、550°C (视结构而决定)
输出信号	4-20mA + HART协议	电气最高耐温	耐温可达125°C
环境温度	-20°C~85°C	桥路阻抗	350 Ohm
相对湿度	20...95%, no condensation	重复性	$\pm 0.1\% \text{ FSO}$
储存温度	-20°C...+125°C	绝缘电阻	1000MOhm@50VDC
防护等级	IP65	负载电阻	4~20mA 0~1100 Ohm
尺寸	详见图纸		
压力量程范围	0~17bar至0~2000bar		



— 螺纹型

尺寸图

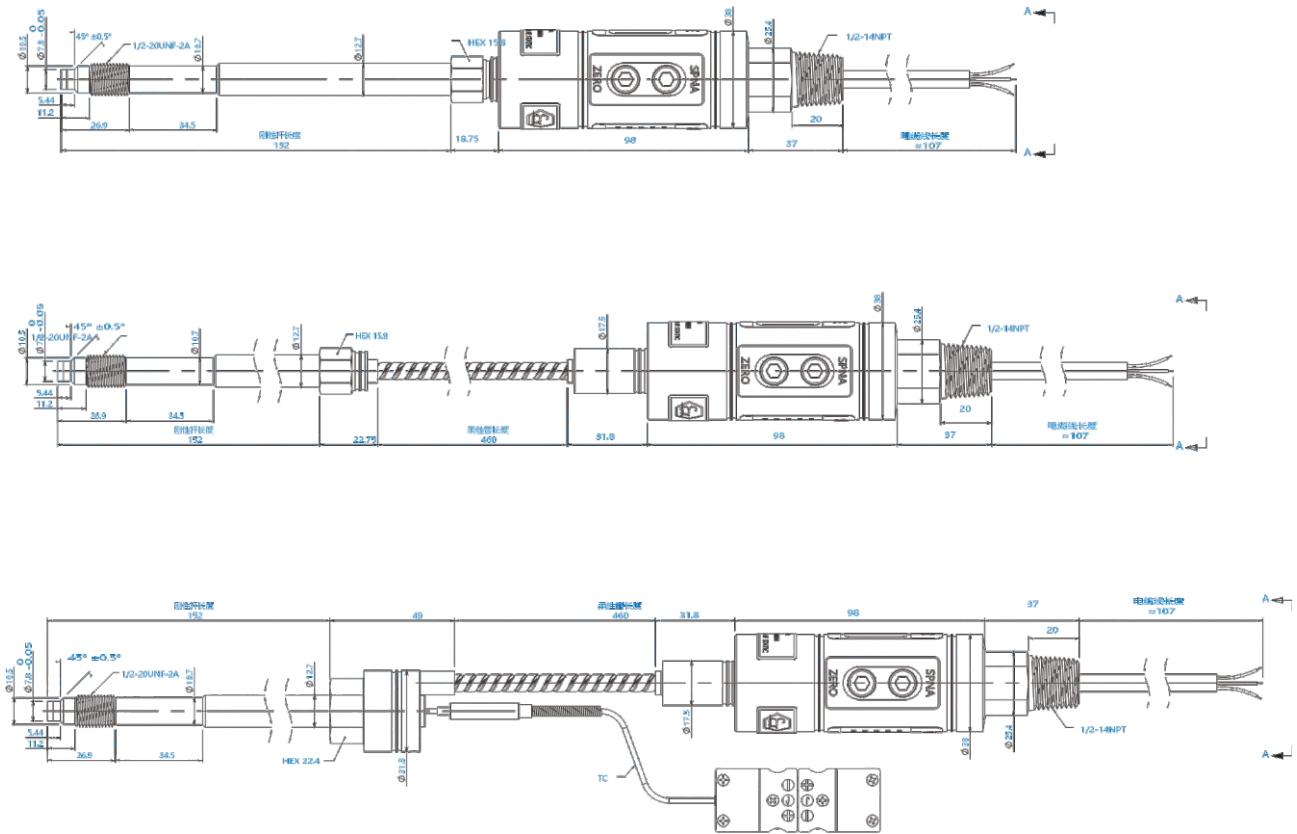

电气连接



6 针航空连接器

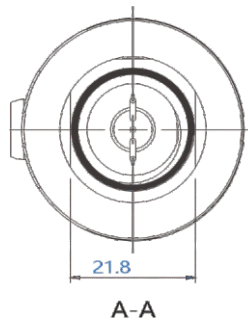

定义	线缆颜色
电源+	红
电源-	黑
底线	绿

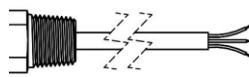
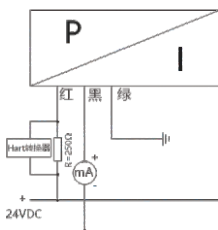

— 法兰型

尺寸图

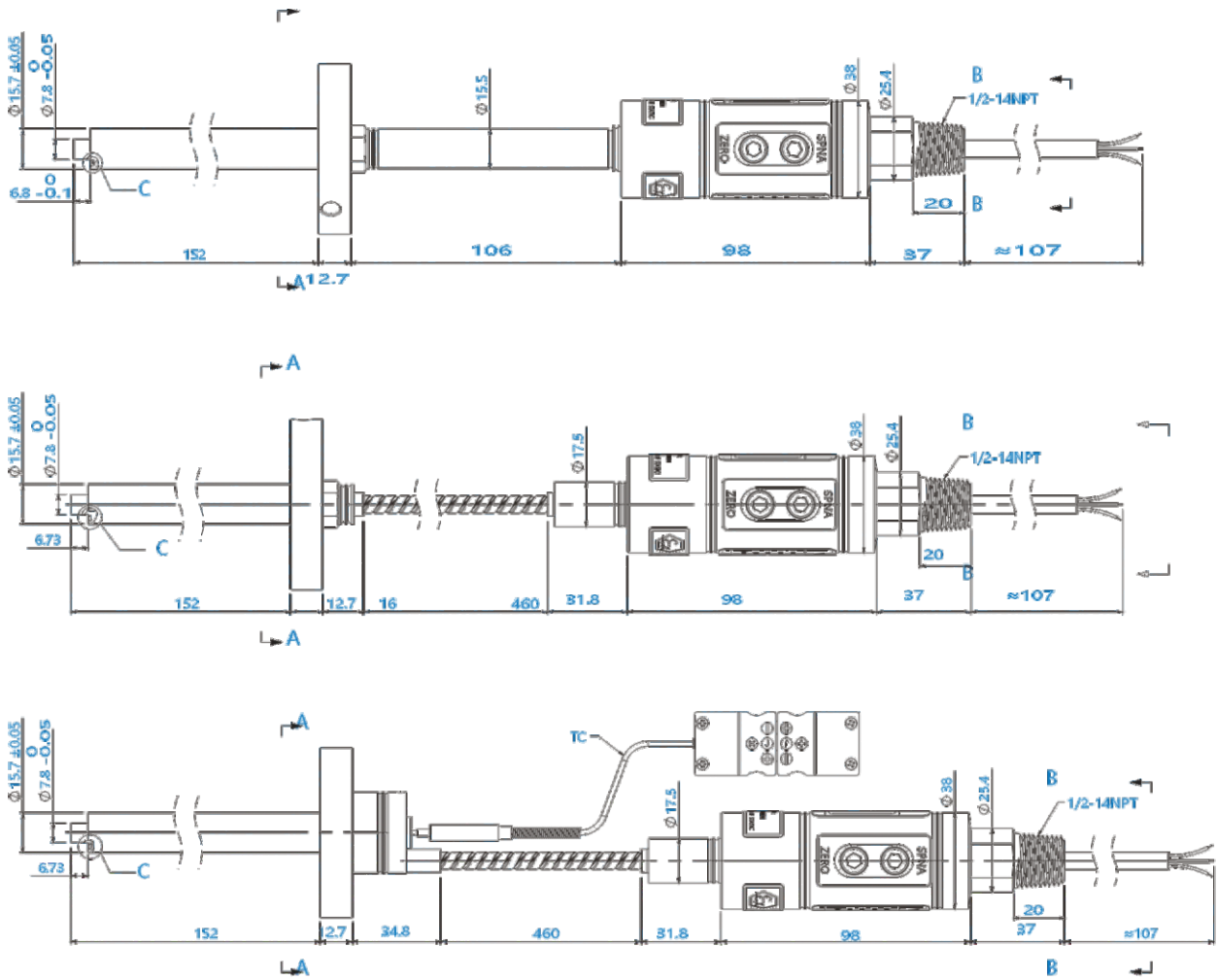

电气连接



6 针航空连接器

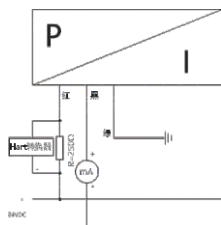
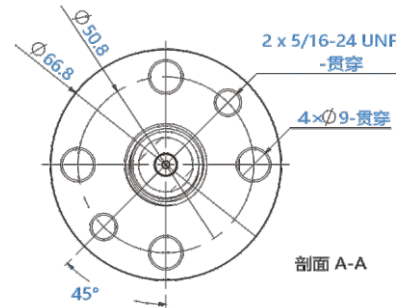
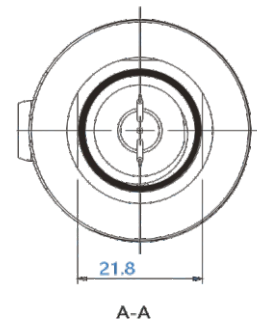

定义	线缆颜色
电源+	红
电源-	黑
底线	绿

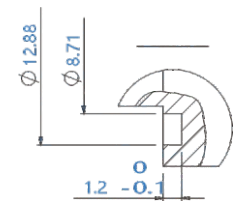
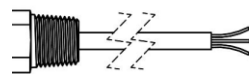

局部视图 C 比例 2:1



订货编码		GMX	X	X	X	X	X	X	X	X	X	X	X	X	X
<input type="checkbox"/>	标准版本														
<input type="checkbox"/>	精度等级	GMX													
	0.25%		1												
	0.50%		3												
<input type="checkbox"/>	信号分辨率														
	4-20mA(2-wire)				E2										
	4-20mA(3-wire)				E3										
	4-20mA(4-wire)				E4										
	4-20mA+HART				E5										
<input type="checkbox"/>	测温元件<热电偶 热电阻>														
	J型热电偶				THJ										
	K型热电偶				THK										
	PT 100热电阻(3线)				PT 3										
	PT 100热电阻(4线)				PT 4										
	无测温元件				N										
<input type="checkbox"/>	安装螺纹														
	M10x1.0A							10A							
	1/2"20UNF 2A							12A							
	M14							14A							
	M18							18A							
	66.8法兰							66A							
	82.6法兰							82A							
<input type="checkbox"/>	测压范围< bar >														
	17	*						B17E							
	35	*						B35E							
	50	*						B50E							
	100							B10Z							
	200							B20Z							
	350							B35Z							
	400							B40Z							
	500							B50Z							
	600							B60Z							
	700							B70Z							
	800							B80Z							
	1000							B10H							
	1400							B14H							
	2000							B20H							
<input type="checkbox"/>	刚性杆尺寸														
	152 mm,6.0" (标准)							S0							
	203 mm,8.0"							S1							
	254 mm,10"							S2							
	318 mm,12.5"							S3							
	356 mm,14.0"							S4							
	457 mm,18.0"							S5							
	38mm,2.0"							S6							
	50 mm,2.0"							S7							
	76 mm,3.0"							S8							
	特殊定制							S9							
<input type="checkbox"/>	柔性杆尺寸														
	无柔性管								F0						
	457 mm,18.0"(标准)								F5						
	610mm, 24.0"								F6						
	760 mm, 30.0"								F8						
	特殊定制								F9						
<input type="checkbox"/>	膜片材质														
	15-5PH不锈钢	**								R					
	Hastelloy 合金	**								H					
	inconel 718合金	**								I					
	特殊定制									S					
<input type="checkbox"/>	填充材质														
	特殊合金液体												W		
<input type="checkbox"/>	电气连接方式														
	6针航空插头(标准)													6P	
	8针航空插头													8P	
	电缆线直接输出<3米电缆 >	***												33	
<input type="checkbox"/>	特殊定制代码														
	无														000
	特殊定制														XXX

